

POST-MIX VALVES

UF-1/UFB POST-MIX VALVES

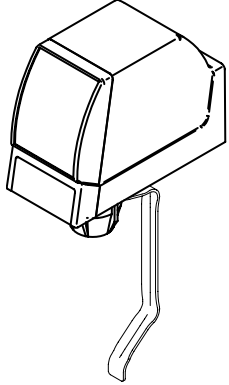

The UF-1/UFB Electric Post-Mix Valve Family is a high reliability, low maintenance group of valves. The product is modular in construction and allows the user to replace or change major assemblies without tools. Models available include basic Sanitary Lever activated valves as well as Portion Control, Self-Serve, and Optifill™ (automatic shut off) electronic versions. UF1/UFB is available in Standard Flow Rates of 1.5 and 2.5 oz per second, Fast Flow 1.5 to 3.0 oz per second and Ultra Flow Rates of 3.0 to 4.5 oz per second. Additionally the UF1/UFB Juice Valve complements a complete line to give our customers flexibility.

- Standard Flow: 1.5 or 2.5 oz per second, non-adjustable, flow washer.
- Fast Flow 1.5 - 3.0 oz per second, adjustable Ceramic flow regulator.
- UFB: 2.0 - 4.0 oz per second, adjustable Ceramic flow regulator.
- Case Quantity: 20 per case @ 34 lbs. per case.

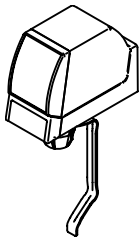

LEVER

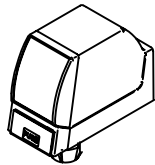

SELF SERVE

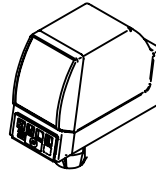

PORTION CONTROL

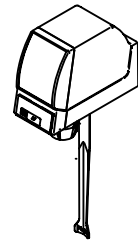

OPTIFILL™

SANITARY LEVER VALVES

BEVCORE Part Number	Manufacture Part Number	Description
1004287	561000120	Fast Flow Ceramic Regulator, without Mounting Block and Covers. 1.5 - 3.0 oz. flow
1008702	561000121	Fast Flow, Ceramic Regulator, with Mounting Block and Covers. 1.5 - 3.0 oz. flow
1008702	561000125	Standard Flow, Flow Washer, with Mounting Block and Covers. 1.5 oz. flow
1029685	561000155	UFB, Ceramic Regulator, without Mounting Block and Covers. 2.0 - 4.0 oz. flow
1029428	561000156	UFB, Ceramic Regulator, with Mounting Block and Covers. 2.0 - 4.0 oz. flow



On-Line Store: www.bevcore.com
 See website for the most current catalogs
 Email: custcare@bevcore.com
 Phone: 866-275-6392
 Fax: 866-329-6392

POST-MIX VALVES

JUICE VALVES

BEVCore Part Number	Manufacture Part Number	Description
1001898	561000126	Fast Flow, Juice Regulator, Sanitary Lever with Mounting Block and Covers 1.5 to 3.0 oz. Flow
1010325	561000124	Fast Flow, Juice Regulator, Sanitary Lever without Mounting Block and Covers, 1.5 to 3.0 oz. Flow
1011413	561000102	Fast Flow, Juice Regulator, Self Serve, Without Mounting Block and Cover, 1.5 to 3.0 oz. Flow

PORTION CONTROL VALVES

BEVCore Part Number	Manufacture Part Number	Description
1008700	2307	Fast Flow, Ceramic Regulator, with Mounting Block and Covers. 1.5 to 3.0 oz. flow
1029689	561000159	UFB, Ceramic Regulator, with Mounting Block and Covers. 2.0 to 4.0 oz. flow
1010810	2312	Fast Flow, Ceramic Regulator, without Mounting Blocks and Covers. 1.5 to 3.0 oz. flow
1029688	561000158	UFB, Ceramic Regulator, without Mounting Block and Covers. 2.0 to 4.0 oz. flow

SELF SERVE VALVES

BEVCore Part Number	Manufacture Part Number	Description
1002018	1966	Fast Flow, Ceramic Regulator, without Mounting Block and Covers. 1.5 to 3.0 oz. flow
1006492	2304	Fast Flow, Ceramic Regulator, with Mounting Block and Covers. 1.5 to 3.0 oz. flow
1029677	561000162	UFB, Ceramic Regulator, with Mounting Block and Covers. 2.0 to 4.0 oz. flow
1029691	561000161	UFB, Ceramic Regulator, without Mounting Block and Covers. 2.0 to 4.0 oz. flow

OPTIFILL™ AUTOMATIC SHUT-OFF

BEVCore Part Number	Manufacture Part Number	Description
1008698	2306	Fast Flow, Ceramic Regulator, with Mounting Block and Covers. 1.5 to 3.0 oz. flow
1029695	561000165	UFB, Ceramic Regulator, with Mounting Block and Covers. 2.0 to 4.0 oz. flow
1008630	2315	Fast Flow, Ceramic Regulator, without Mounting Block and Covers. 1.5 to 3.0 oz. flow
1029694	561000164	UFB, Ceramic Regulator, without Mounting Block and Covers. 2.0 to 4.0 oz. flow

OPTIONS/ACCESSORIES FOR UF-1

BEVCore Part Number	Manufacture Part Number	Description	Order Multiples
1010839	3297	Water Lever only and Instruction Sheet	
1010859	319540000	Brix Tube only (standard for SF1 and UF1)	
1009961	4247	Kit - Converts a Ultra Flow Valve to a Fast Flow Valve, (Ceramic)	
1010888	2325	Push Here Module with Harness	
1004290	3518	Portion Control Module with Harness	
1001812	1951	Front Cover W/Cutout (Required when converting to Portion Control or Self Serve)	Order in Multiples of 10
1006177	318994001	Pigtail Installation Extension for Valve Panel	
1010847	1919	UF-1 Mounting Block Assy. Uses Standard or Dole inlet fittings.	
1008509	569000202	Kit Parts Spare Uf1	
1006372	318762000	Fitting Retainer (Back Block "S" Clip) Requires 1 screw #1081	Order in Multiples of 10
1005143	1081	Screw Stainless Steel (for "S" Retainer Clip)	Order in Multiples of 10
1010479	560001937	UF-1 Timer Kit	
1008682	1922	UF-1 Nozzle Kit	
1007115	4176	Label Water Arrow (for Push Button Valve) Small	
1009449	4177	Label Water Push Down Arrow (for Lever Valve) Large	
1009315	560002803	Label Soda Arrow (for Push Button Valve) Small	
1002471	560002804	Label Soda Push Down Arrow (for Lever Valve) Large	

* Fast Flow to Ultra Flow

POST-MIX VALVES

UF-1 DISPENSING VALVE

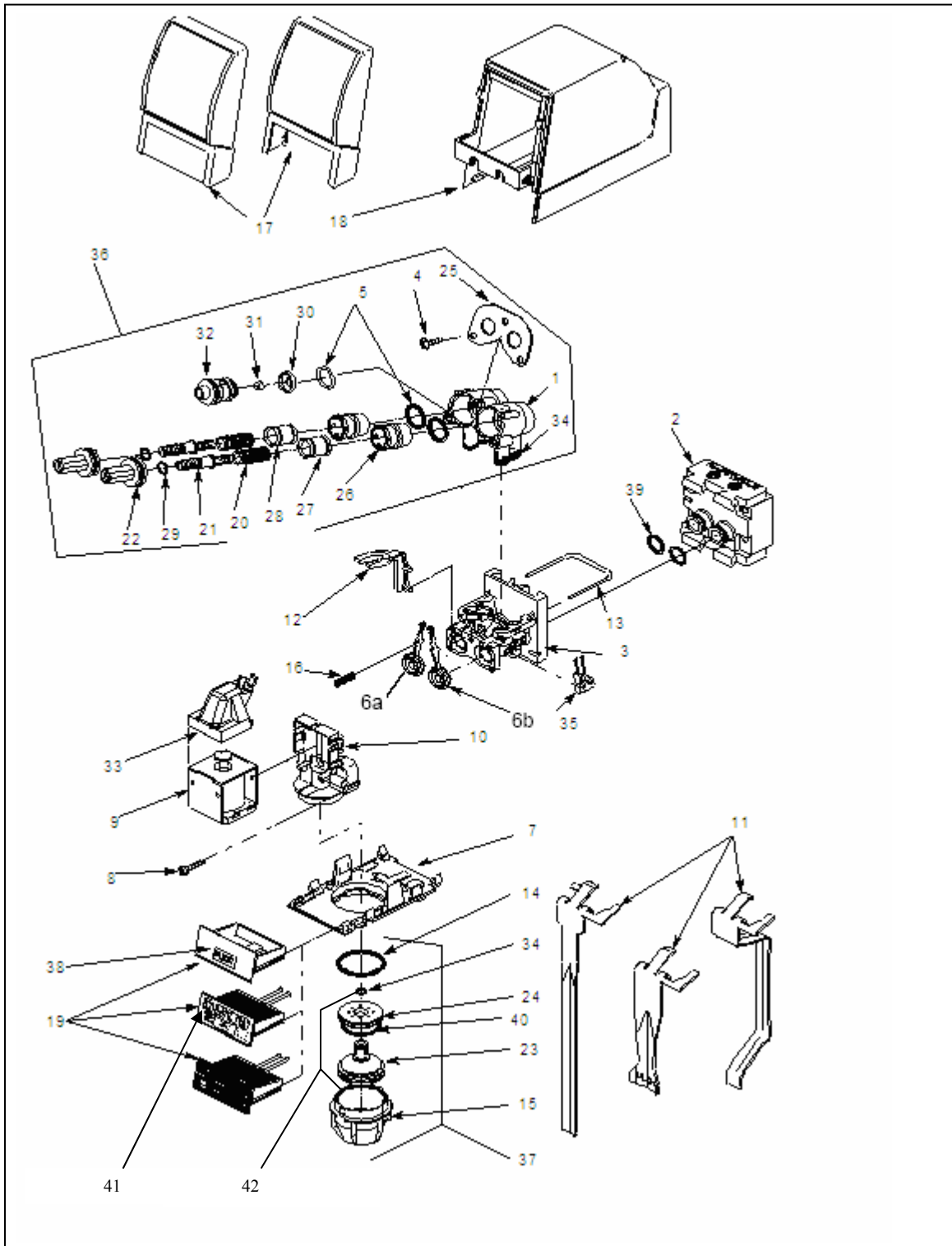



On-Line Store: www.bevcore.com
 See website for the most current catalogs
 Email: custcare@bevcore.com
 Phone: 866-275-6392
 Fax: 866-329-6392

POST-MIX VALVES, UF-1 VALVE PARTS

No.	BEVCORE Part No.	Manufacture Part No.	Description	Order Multiple
1	1008325	1907	Housing, Flow Control	
2	1010847	1919	Block, Mounting (complete)	
3	1003883	1900	Valve Body wo/switch	
4	1009688	560001108	Thread Cutting Screw, Phil Pan Hd., No. 8-16 x 3/4-In.	Order in Multiples of 50
5	1001883	317816000	O-Ring, .676 I.D.	Order in Multiples of 10
6a	1006324	560003995	Banjo Valve Santoprene Water Only	
6b	1004208	1947	Valve Inlet Uf1 Banjo valve black Syrup	Order in Multiples of 10
7	1003717	1903	Plate Bottom	
8	1007018	2318	Plastic Screw, Phil Rd Hd, No. 6-19 x 3/4" Long.	Order in Multiples of 10
9	1010788	1918	Solenoid with Plunger, AC	
9b	1007928	2168	Plunger only, Solenoid, AC	
10	1008098	1901	Valve Head	
	1003872	1902	Valve Head, OptiFill	
11a	1005967	4965	Lever, Standard, 11	
11b	1008276	560003252	Lever, OptiFill, 11	
11c	1001892	560003193	Lever, Self Serve, 11	
12	1009809	1911	Actuator	Order in Multiples of 10
13	1000434	1930	Retainer, U-Pin	Order in Multiples of 10
14	1008384	183184000	O-Ring 1.174 I.D.	Order in Multiples of 10
15	1004041	1945	Nozzle - Black	Order in Multiples of 10
15a	1037812	620715824	Nozzle - Clear	Order in Multiples of 10
15b	1032510	620715820	Nozzle - Green	Order in Multiples of 10
15c	1020974	560006166	Nozzle - Mt. Dew Rd	Order in Multiples of 10
15d	1007013	560005511	Nozzle - Mt. Dew Green	Order in Multiples of 10
16	1005770	1931	Spring	Order in Multiples of 50
17	1001716	1956	Cover Front, Lever Actuated & OptiFill	
	1001812	1951	Cover Front, Self-Serve & Portion Control.	Order in Multiples of 10
18	1006226	1950	Cover, Rear	
19	1010888	2325	Module Ass'y, Self Serve	
	1004290	3518	Module Ass'y, Portion Control	
	1010897	4391	Module Ass'y, OptiFill	
20	1003186	1940	Spring	Order in Multiples of 10
21	1011416	560003256	Adjusting Screw	Order in Multiples of 10
22	1005319	1909	Top Flow Control	Order in Multiples of 10
23	1004153	1917	Nozzle, Inner Ass'y	
	1003527	560001733	Diffuser, Juice	
24	1010662	1913	Diffuser	Order in Multiples of 10
25	1007131	1929	Retainer	Order in Multiples of 10
26	1001775	1934	Sleeve, Std.	
	1007930	4386	Sleeve, Juice	
27	1010808	310480011	Piston, Syrup, 1.5 - 3 oz/sec.	
	1010335	1937	Piston, Syrup, 3 - 4.5 oz/sec.	



On-Line Store: www.bevcore.com
 See website for the most current catalogs
 Email: custcare@bevcore.com
 Phone: 866-275-6392
 Fax: 866-329-6392

POST-MIX VALVES, UF-1 VALVE PARTS (CON'T)

No.	BEVCore Part No.	Manufacture Part No.	Description	Order Multiple
28	1004192	310754011	Piston, Water, 1.5 - 3 oz/sec.	
	1020953	560006006	Piston, Water Regulator Ceramic 2-4 oz/sec	
29	1003975	150309000	O-Ring, .208 I.D.	
30	1007609	319546011	Cap Housing, Water Flow Washer.	Order in Multiples of 10
31	1010664	311194000	Water Flow Washer, 1.5 oz/sec.	
	1003783	319547011	Water Flow Washer, 3 oz/sec.	
32	1007805	1949	Housing, Water Flow Washer.	
33	1001135	560003083	Cover, Solenoid	Order in Multiples of 10
34	1010751	4073	O-Ring, .239 I.D. x .070 C.S.	Order in Multiples of 10
35	1010691	4263	Switch, with Wires	
	1003983	560002596	Switch, Optifill	
	1010303	560000795	Switch, Standard	Order in Multiples of 10
	1004024	1923	Switch, Self Serve	
	1010888	2325	Switch, Assembly, Complete	
36	1001957	1954	Module, Flow Control Assembly, 1.5 - 3 oz/sec.	
	1029847	560006408	Module, Flow Control Assembly, 2-4 oz/sec.	
	1005761	1957	Module, Flow Control Assembly w/Flow Washer, 1.5 oz/sec.	
	1010325	561000124	Module, Flow Control Assembly, 1.5 - 3 oz/sec., Juice	
37	1008682	1922	Nozzle Assembly, Std	
	1003881	560001734	Nozzle Assembly, Juice	
	1012416	561000154	Nozzle Assy Mid Range Uf1 mtdw	
	1005953	561000141	Kit Nozzle Uf-1 Mnt Dew	
38	1007833	1943	Push Overlay	
39	1003933	312414000	O-Ring, .426 I.D. x .070 C.S.	Order in Multiples of 10
40	1001667	311086000	O-Ring, 926 I.D.	
41	1030496	560005124	Overlay, UF-1 Portion Control	
42	1038959	811917	Kit, Inner Nozzle UF-1 Valve	
	--- PARTS KITS - NOT SHOWN ---			
	1010839	3297	Plain Water Lever Kit	
	1005212	4024	Grounding Kit	
	1000013	811900	Basic O-Ring Kit	
	1008509	569000202	Complete Spare Parts Kit	
	1001892	560003193	Self-Serve Lever	
	1010479	560001937	Timer, 2 Second	
	1001313	630300373	Harn Wire Jumper for Opti-fill	

POST-MIX VALVES

SF-1 ELECTRIC POST-MIX VALVES

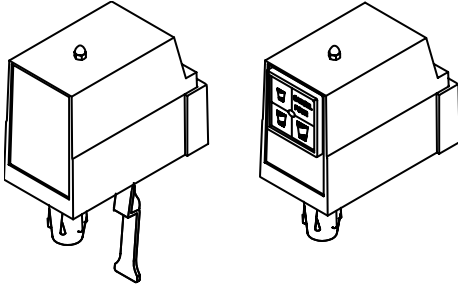

The SF-1 Electric Post-mix Valve is a reliable, smooth flow dispensing valve. The SF-1 standard flow dispenses 1.5 ounces per second, while the fast flow can be adjusted from 1.5 ounces to 3.0 ounces per second. Almost any existing dispenser can be retrofitted to either SF-1 Electric Post Mix Valve. The SF-1 valve incorporates built-in syrup and water flow controls, a simplified nozzle and spout, and quick connects back block assembly.

ADDITIONAL INFORMATION ON SF-1 ELECTRIC POST-MIX VALVES

Standard Flow: Valve includes a water flow washer and a syrup flow regulator; dispenses 1.5 ounces per second.

Fast Flow: Valve includes ceramic water and syrup flow regulators; dispensing is adjustable from 1.5 ounces to 3.0 ounces per second.

Ordering: Valves by the carton
 With Cover and Mounting Block
 25 units per carton
 29 lbs.

Without Cover and Mounting Block
 30 units per carton
 26 lbs.

LEVER CONTROL VALVES

BEVCORE Part Number	Manufacture Part Number	Description
1006461	318807015	Standard Flow, with Cover and Mounting Block, without Water Lever. 1.5 oz. flow (Flow washer)
1004197	318806015	Standard Flow, with Cover and Mounting Block, with Water Lever. 1.5 oz. flow (Flow washer)
1010878	317849015	Standard Flow, without Cover and Mounting Block. 1.5 oz. flow (Flow washer)
1008695	318812015	Fast Flow, with Cover and Mounting Block, without Water Lever. 1.5 to 3.0 oz. flow (Ceramic Regulator)
1006415	318813015	Fast Flow, with Cover and Mounting Block, with Water Lever. 1.5 to 3.0 oz. flow (Ceramic Regulator)
1006481	317847015	Fast Flow, without Cover and Mounting Block. 1.5 to 3.0 oz. flow (Ceramic Regulator)

LEVER CONTROL VALVES SPARE PARTS AND ACCESSORIES

BEVCORE Part Number	Manufacture Part Number	Description	Order Multiples
1001969	317884011	Cover Assembly, without Water Lever	
1001920	317879014	Cover Assembly, with Water Lever	
Call	317905XXX	Large Decal for Front Cover (Specify Flavor) Call For Pricing	
Call	317904XXX	Small Decal for Rear Cover (Specify Flavor) Call For Pricing	
1006116	309842000	Acorn Nut for Cover	Order in Multiples of 10



On-Line Store: www.bevcore.com
 See website for the most current catalogs
 Email: custcare@bevcore.com
 Phone: 866-275-6392
 Fax: 866-329-6392

POST-MIX VALVES

SF-1 ELECTRIC POST-MIX VALVES

AUTOMATIC CUP FILLING VALVES

BEVCORE Part Number	Manufacture Part Number	Description
1006464	309680017	Fast Flow, with Cover, w/o Mounting Block, and Water Lever. 1.5 to 3.0 oz. Flow (Ceramic Regulator)

AUTOMATIC CUP FILLING VALVE SPARE PARTS AND ACCESSORIES

BEVCORE Part Number	Manufacture Part Number	Description
1010872	*2702	Circuit Board
1008600	*309859000	Lever Valve Acfil Replc
1003834	*317783011	Microswitch

Note: * When converting standard SF1 to Automatic Cup Filling Technology, these three part numbers are required.

PORTION CONTROL VALVES

BEVCORE Part Number	Manufacture Part Number	Description
1008372	*318853015	Standard Flow, with Cover and Mounting Block, without Water Lever. 1.5 oz. flow (Flow washer)
1003818	*317850015	Standard Flow, without Cover and Mounting Block. 1.5 oz. flow (Flow washer)
1001803	*2103	Fast Flow, with Cover and Mounting Block, without Water Lever. 1.5 to 3.0 oz. flow (Ceramic Regulator)
1001802	*317848015	Fast Flow, without Cover and Mounting Block . 1.5 to 3.0 oz. flow (Ceramic Regulator)

PORTION CONTROL VALVE SPARE PARTS AND ACCESSORIES

BEVCORE Part Number	Manufacture Part Number	Description	Order Multiples
1008542	317884012	Cover Assembly, without Water Lever	
1001894	317879015	Cover Assembly, with Water Lever	
1006485	*317891015	Portion Control Module	
1004069	163429002	80 VA Transformer	
Call	317904XXX	Decal for Cover (Specify Flavor) Please call for pricing	
1006116	309842000	Acorn Nut for Cover	Order in Multiples of 10

NOTE: *When adding Portion Control or Automatic Fill Valves, a 80VA rated transformer part number 1004069 (163429002) is required to make this modification.

POST-MIX VALVES

SF-1 POST-MIX DISPENSING VALVE

SF-1 VALVE ASSEMBLY

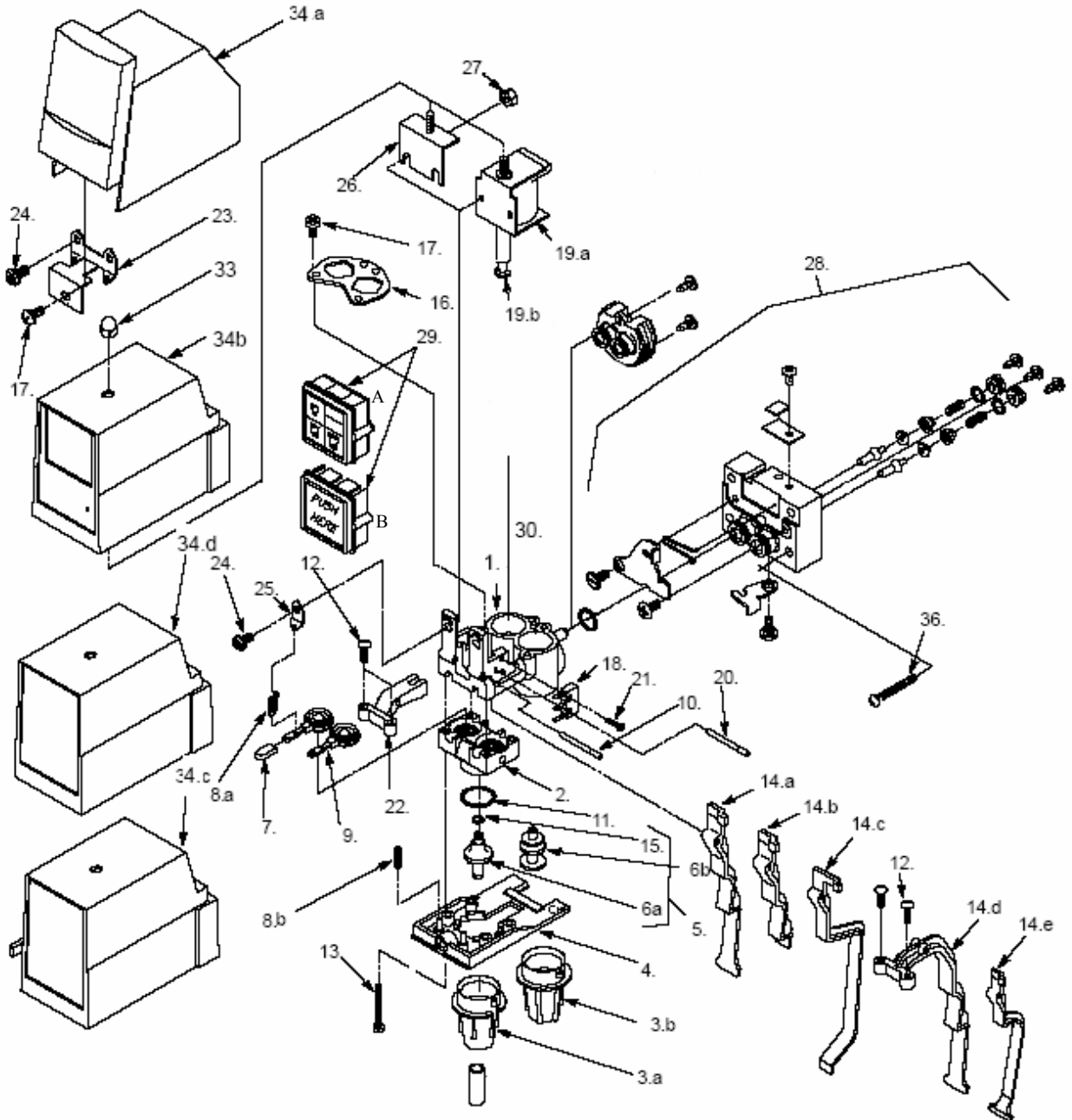



On-Line Store: www.bevcore.com

See website for the most current catalogs

Email: custcare@bevcore.com

Phone: 866-275-6392

Fax: 866-329-6392

POST-MIX VALVES, SF-1 POST-MIX DISPENSING VALVE

Index No.	BEVCORE Part No.	Manufacture Part No.	Description	Order Multiple
1	1008354	3073	Body, Retro-No Latch No Pin	
	1010630	0414	Body, Sabre Latch and Pin	
	1007938	3076	Body, No Latch / Pin Only	
	1006469	3074	Body, Latch and Pin	
2	1008591	317639051	Block, Valve, Non-Carb	
	1010008	309997000	Block, Valve, Sabre	
3.a	1008670	317649000	Nozzle, Standard	
3.b	1006221	309994013	Nozzle, Sabre	
4	1004077	317718000	Support, Cover, Standard	
	1009900	309162000	Support, Cover, Sabre	
5	1002071	318523088	Baffle and O-Ring (Includes a and 15.)	
6.a	1002071	318523088	Baffle, Standard	
	1001581	318754011	Baffle, Hi-Flow and Diet	
	1003925	319330088	Baffle, Non-Carb	
6.b	1004190	309951000	Baffle, Sabre	
7	1006020	317782000	Nib, Long, Water	Order in Multiples of 10
8.a	1001440	317723000	Spring, Extension	Order in Multiples of 10
8.b	1002734	3705	Spring, Compression	Order in Multiples of 100
9	1010871	311355000	Valve Inlet	
10	1003217	319693000	Pin, Groove	Order in Multiples of 10
11	1006068	398033013	O-Ring, .799 I.D. By .070 C.S.	Order in Multiples of 10
12	1005279	314813009	Set Screw, No. 8-32 By 1/2-In. Long	Order in Multiples of 10
13	1002922	317828000	Thread Rolling Screw, Phil Rd. Hd., No. 6-32 By 1-1/4-In. Long	Order in Multiples of 10
14.a	1004129	317721000	Lever, Electric	
14.b	1007065	318675000	Lever, Electric, cut-off	
14.c	1010230	3282	Lever, Self-Serve	
14.d	1005932	317646007	Lever, Manual	
	1001103	309960013	Lever, Sabre	
	1005509	2457	Lever, Tea (Not Shown)	
14.e	1008600	309859000	Lever Valve Acfil Replc	
	1008348	319541000	O-Ring, .157 I.D. By .070 C.S.	Order in Multiples of 10
16	1003628	4147	Retainer, for Flow Control Body	
17	1005763	317784000	Thread Cutting Screw, Phil Truss Hd., No. 8-18 By 1/2-In. Long	Order in Multiples of 10
18	1006386	317783000	Micro Switch, Electric, 3-Pin	
	1003834	317783011	Micro Switch, Continuity, Accufill	
	1010303	560000795	Micro Switch, Electric, 2-Pin	Order in Multiples of 10
19.a	1001868	312017000	Solenoid, 24V.	
	1006428	312017011	Solenoid, 24V., With Stud	
19.b	1001813	318589000	Solenoid Plunger only	



On-Line Store: www.bevcore.com
 See website for the most current catalogs
 Email: custcare@bevcore.com
 Phone: 866-275-6392
 Fax: 866-329-6392

POST-MIX VALVES, SF-1 POST-MIX DISPENSING VALVE (CON'T)

Index No.	BEVCore Part No.	Manufacture Part No.	Description	Order Multiple
20	1005514	317820000	Pin, Lever, Electric	Order in Multiples of 10
21	1005190	1618	Pin, Lever, Continuity	
	1007475	317825000	Machine Screw, Phil Truss Hd., No. 2-56 By 7/16-In. Long, Electric	Order in Multiples of 10
22	1009299	317825001	Thread Forming Screw, Phil Rd. Hd No. 2-28 by .437 Long	Order in Multiples of 10
	1003774	317703007	Arm, Solenoid, Electric	
23	1002458	309157000	Bracket, Cover, Sabre	
24	1007654	3337	Bracket, Cover, Tea	
	1009462	309029000	Machine Screw, Phil Pan Hd., No. 10-32 By 7/16-In. Long	Order in Multiples of 10
25	1005248	319692000	Retainer, Spring	Order in Multiples of 10
26	1003546	309843000	Bracket, Cover, Manual	
27	1009228	398024400	Hex Nut, Stainless Steel, No. 10-32 Manual	Order in Multiples of 10
28	1006490	318838015	Block Ass'y, Standard (See Page 24-11)	
	1006394	319166015	Block Ass'y, Retrofit (See Page 24-11)	
	1001889	309950015	Block Ass'y, Sabre (See Page 24-11)	
29a	1006485	317891015	Portion Control Ass'y	
29b	1006419	309941000	Portion Control Ass'y	
30	1000117	380046000	Restrictor, Spain	Order in Multiples of 10
32	1008876	317895000	Thread Cutting Screw, Phil Pan Hd. Stainless Steel, No. 10-32 By 1/2-In. Long (Threaded Block)	Order in Multiples of 10
33	1006116	309842000	Acorn Nut, No. 10-32	Order in Multiples of 10
34.a	1008376	309158000	Cover, Sabre	
34.b	1008542	317884012	Cover, W/O Lever, Portion Control	
34.c	1001920	317879014	Cover, With Lever, Electric and Manual	
	1001894	317879015	Cover, With Lever With Portion Control	
34.d	1001969	317884011	Cover, W/O Lever, Electric and Manual	
34.e	1001894	317879015	Cover, With Lever, Portion Control	
35	1000691	317645051	Block, Threaded	
36	1008432	317821000	Wire Harness, (Not Shown)	
37	1003711	318308000	Thread Rolling Screw, Phil Pan Hd Stainless Steel, No. 10-32 By 1-In Long	Order in Multiples of 10

POST-MIX VALVES

Self Serve Valves

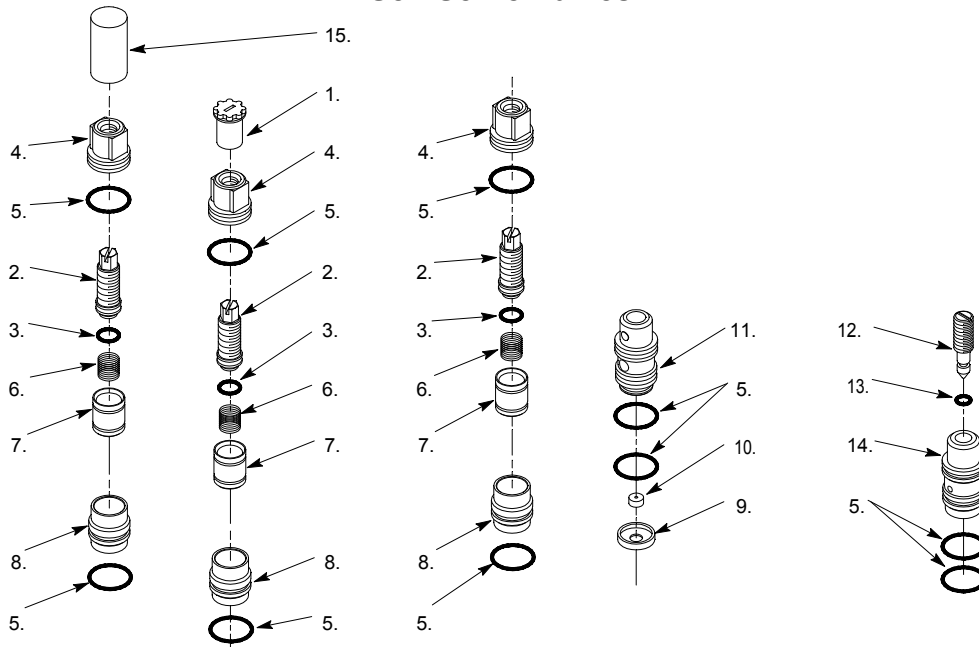

FAST FLOW VALVE

FLOW WASHER (STANDARD VALVE)

NEEDLE or GATE VALVE

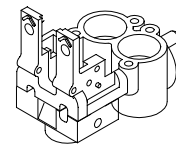
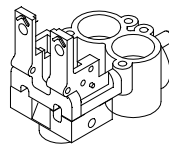
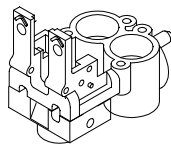

Index No.	BEVCORE Part No.	Manufacture Part No.	Description	Order Multiples
1	1003451	309991000	Knob, Syrup Regulator	Order in Multiples of 10
2	1004052	310632051	Adjusting Screw	
3	1010752	180025000	O-Ring, .364 I.D. By .070 C.S.	Order in Multiples of 10
4	1004134	319133051	Top, Flow Control	
5	1001883	317816000	O-Ring, .676 I.D. By .070 C.S.	Order in Multiples of 10
6	1010055	310482000	Spring	Order in Multiples of 50
7	1004192	310754011	Piston, Water, Ceramic	
	1010808	310480011	Piston, Syrup, Ceramic	
	1010335	1937	Piston, Syrup, Juice	
8	1002036	317431011	Sleeve, Ceramic	
9	1007609	319546011	Retainer	Order in Multiples of 10
10	1010664	311194000	Flow Washer, .60 GPM	
11	1006078	319545051	Housing, Flow Washer, SF-1	
	1007040	309711000	Housing, Flow Washer, Sabre	
12	1003978	319535008	Needle Valve	
13	1001152	140092000	O-Ring, .114 I.D. By .070 C.S.	Order in Multiples of 10
14	1001477	319138000	Housing, Needle Valve	
	1004021	4026	Gate Flow Cntl Assembly Non-Carb	
15	1002532	309992000	Cap, Water	

POST-MIX VALVES

SF-1 Valve Block Assembly

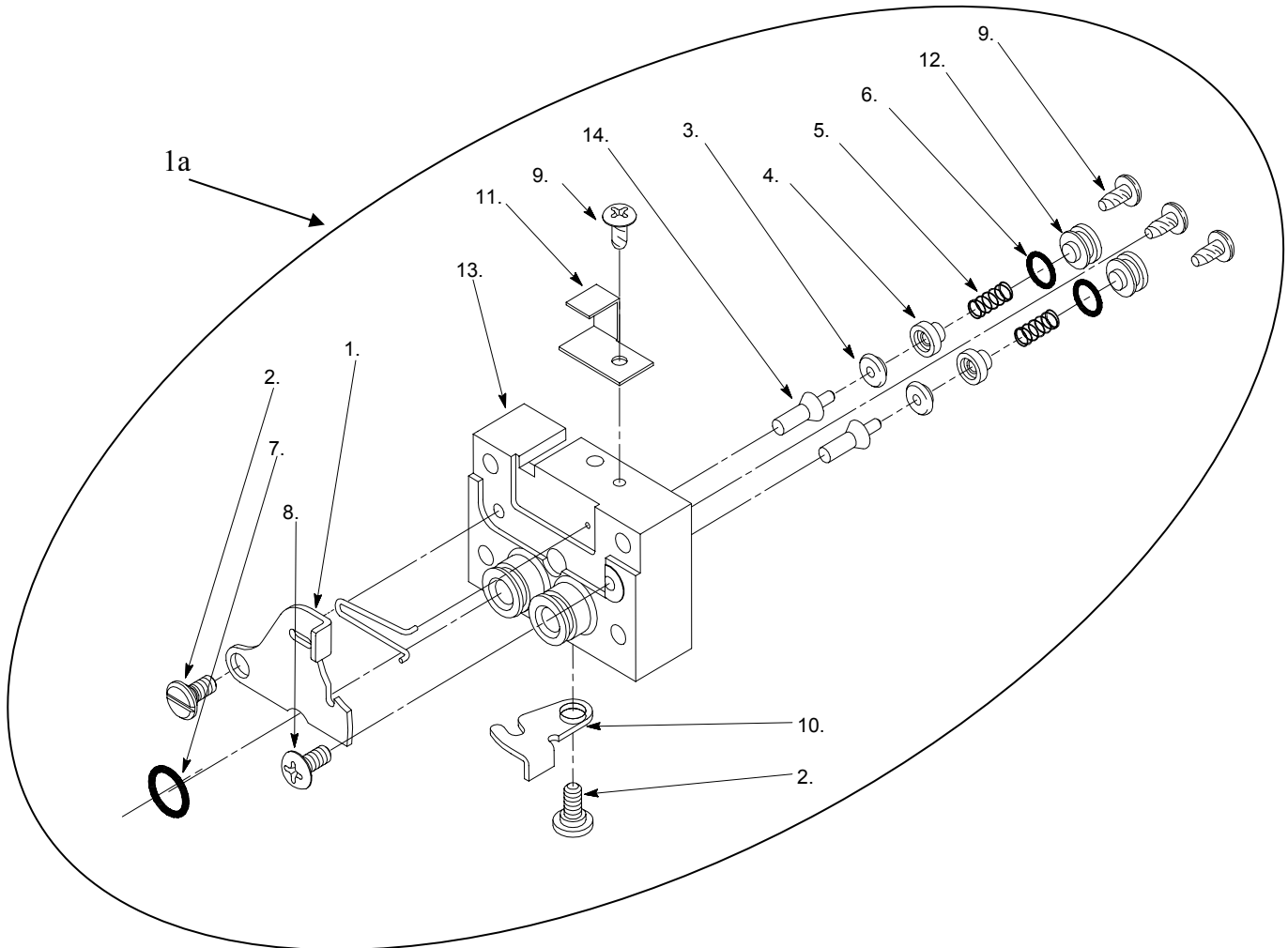



On-Line Store: www.bevcore.com

See website for the most current catalogs

Email: custcare@bevcore.com

Phone: 866-275-6392

Fax: 866-329-6392

POST-MIX VALVES, SF-1 VALVE BLOCK ASSEMBLY

Index No.	BEVOCRe Part No.	Manufacture Part No.	Description	Order Multiple
1a	1006490	318838015	Block Ass'y, Standard (White)	
Inc. items 1-14	1006394	319166015	Block Ass'y, "C" Block (Black)	
	1001889	309950015	Block Ass'y, Sabre	
1	1002688	319095000	Lever	
2	1009941	317777001	Shoulder Screw, Slotted, Stainless Steel, No. 8-32 By 5/16-In. Long	Order in Multiples of 10
3	1006357	180018053	Washer, Rubber	Order in Multiples of 10
4	1002884	178019006	Retainer, Washer	Order in Multiples of 10
5	1006966	309804000	Spring	Order in Multiples of 10
6	1005897	197222000	O-Ring, .239 I.D. By .070 C.S.	Order in Multiples of 10
7	1010752	180025000	O-Ring, .364 I.D. By .070 C.S.	Order in Multiples of 10
8	1005763	317784000	Thread Cutting Screw, Phil Truss Hd., Stainless Steel, No. 8-32 By 1/2-In. Long	Order in Multiples of 10
9	1000332	151841000	Thread Rolling Screw, Phil Pan Hd. Stainless Steel, No. 6-19 By 5/16-In. Long	Order in Multiples of 10
10	1000950	0147	Latch	Order in Multiples of 10
11	1011092	300592000	Clip, Cover, Sabre	Order in Multiples of 10
12	1006918	317713000	Cap, Connector	
13	1001931	3077	Block, Standard	
	1000574	0408	Block, Retrofit	
	1001889	309950015	Block, Sabre	
14	1007331	317702001	Stem, Poppet	Order in Multiples of 10

POST-MIX VALVES

SELF SERVE PUSH BUTTON VALVES (Available as Fast Flow w/Ceramic Regulators, only)

BEVCORE Part Number	Manufacture Part Number	Description
1002053	1690	Fast Flow, Push Button, with Cover and Mounting Block, without Water Lever. 1.5 to 3.0 oz. flow

SELF SERVE PUSH BUTTON VALVE SPARE PARTS AND ACCESSORIES

BEVCORE Part Number	Manufacture Part Number	Description	Order Multiple
1008542	317884012	Cover Assembly, without Water Lever	
1001894	317879015	Cover Assembly, with Water Lever	
1006419	309941000	Switch, Push Button	
Call	317904XXX	Decal for Cover (Specify Flavor)	
1006116	309842000	Acorn Nut for Cover	Order in Multiples of 10

JUICE VALVES (Specifically designed for juice type product application)



BEVCORE Part Number	Manufacture Part Number	Description
1010742	3328	Fast Flow - Gate Valve - Electric Lever. 1.5 to 3.0 oz. flow, w/o cover and mounting block
1004121	3419	Fast Flow - Gate Valve - Push Button Electric. 1.5 to 3.0 oz. flow, w/o cover and mounting block

TEA UNIT VALVES

	BEVCORE Part Number	Manufacture Part Number	Description	Order Multiple
	1010419	300096015	Tea Valve, Manual Lever, with Water and Syrup Flow Regulators, without Cover 1.5 to 3.0 oz. flow	
	1010153	2458	Tea Valve, Manual Push Bar, with Water and Syrup Flow Regulators, without Cover. 1.5 to 3.0 oz. flow	
	1001969	317884011	Cover Assembly, without Water Lever	
	1006116	309842000	Acorn Nut for Cover	Order in Multiples of 10

Note: Tea Unit Valves are for non-carbonated beverages; they can be converted to carbonated beverage if baffle is changed. Use baffle assembly 1002071.

McCANN™ 2-FLAVOR VALVE

	BEVCORE Part Number	Manufacture Part Number	Description
	1016030	630901029	27 Series, 2 Flavor Valve, 3 Metering Stems
	1012556	630901030	27 Series Valve Back Block





POST-MIX VALVES

SPARE PARTS AND ACCESSORIES FOR SF-1 AND UF-1 VALVES

	BEVCORE Part Number	Manufacture Part Number	Description	Order Multiples
	1010230	3282	Sanitary Lever for SF-1	
	1006490	318838015	Standard Valve Block Assembly with Latch, for SF-1 Valves only (White)	
	1006394	319166015	Dole Conversion Valve Block Assembly with Latch, for SF-1 Valves only "C" Block (Black)	
	1010732	77842100	Standard Inlet Fitting, fits .156 tubing, without o-ring, (Requires o-ring 1008496). Fitting used on Standard Valve Block (1006490).	
	1010686	77840200	Standard Inlet Fitting, fits .250 and .265 tubing, without o-ring, (Requires o-ring 1008496). Fitting used on Standard Valve Block (1006490).	
	1001064	77840800	.156 straight SS Inlet Fitting w/o o-ring, Fitting used on Dole conversion block 1006394	
	1001116	77050600	Straight Inlet McCann 1/4" Barb	
	1004048	77050300	.370 Dole Straight Inlet Fitting, fits .265 tubing, without o-ring, (Requires o-ring (1008496). Fitting used on Dole Conversion Block (1006490).	
	1003955	2212	.360 OD x 1/4 Barb Standard 75° Inlet Fitting, fits .250 and .265 tubing, without o-ring, (Requires o-ring 1008496). Fitting used on Standard Valve Block (1006490).	
	1001954	77051500	.370 Dole 102° Elbow Inlet 1/4" Barb	
	1001863	77052200	.370 Dole 45° Inlet 1/4" Barb	
	1003855	77050100	.370 Dole 90° Inlet Fitting, fits .265 tubing, without o-ring, (Requires o-ring (1008496). Fitting used on Dole Conversion Block 1006490	
	1001991	77052100	.360 OD x 1/4 Barb 102° Inlet Fitting, (Requires o-ring 1008496)	
	1008496	317015000	O-ring for all inlet fittings	Order in Multiples of 10
	1006372	318762000	Fitting Retainer (Back Block "S" Clip) Requires 1 Fitting Retainer Screw (1005601)	Order in Multiples of 10
	1005601	398023208	Fitting Retainer Screw	Order in Multiples of 10
	1003711	318308000	Valve Block Mounting Screw (4 required per valve)	Order in Multiples of 10
	1006116	309842000	Acorn Nut for Cover	Order in Multiples of 10

POST-MIX VALVES

SPARE PARTS AND ACCESSORIES FOR SF-1 AND UF-1 VALVES, (CONT'D)

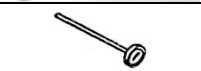
	1010859	319540000	Syrup Bypass Assembly (standard for SF1 and UF1)	
	1010809	311100000	Cornelius Proportioning Cup 5.5 to 1 and/or 5 to 1 ratio	
	1010479	560001937	UF-1 Timer Kit	
	1005882	1502	Sleeve Puller for SF-1 Valve	
	1006408	511004000	Refractometer, 0-30 Scale	
	1001864	1767	SF1 Valve Repair Kit.	
	1001503	CT220X4	Pocket Beverage Thermometer, Bimetal, 1" Dial, 5" Stem, 0-222° F with Cornelius Logo	





PRE_MIX VALVES

PRE-MIX VALVES

These widely used Pre-Mix Dispensing Valves feature positive flow control, preventing carbonation loss. The slotted adjustment screw can be easily set to deliver product at varying flow rates. These valves are designed to dispense bottle quality pre-mixed product.

	BEVCORE Part Number	Manufacture Part Number	Description
	1008308	252462039	Self-Closing Valve, Long Shank (with no T-Handle or Fittings)
	1000018	252462139	Self-Closing Valve, Long Shank Complete with T-Handle and 5/16 x 1/4 Fl. Elb. (P/N 1010796 & 1007854)
	1002211	252462239	Self-Closing Valve, Long Shank Complete with T-Handle and 5/16 x 1/2 Fl. Elb. Elbow (P/N 1010796 & 1005667)
	1004025	252539039	Self-Closing Valve, Short Shank (with no T-Handle or Fitting)
	1004427	252539139	Self-Closing Valve, Short Shank Complete with T-Handle and 1/4" Yoke Fitting (P/N 1010796 & 1010567)
	1000015	252539239	Self-Closing Valve, Short Shank Complete with T-Handle and 1/2" Yoke Fitting (P/N 1010796 & 1010401)
	1006238	252458039	High Style Squeeze Valve (Valve Only, No Fittings)
	1000014	252458100	High Style Squeeze Valve Complete with Fitting (P/N 1001357)
	1013068	252458200	High Style Squeeze Valve Complete with Fitting (P/N 1001106)

PRE-MIX VALVE ACCESSORIES AND SPARE PARTS

	BEVCORE Part Number	Manufacture Part Number	Description	Order Multiple
	1008060	151607000	Push Lever Kit for Self--Closing Valve without Futura Knob	
	1005813	151674000	Push Lever Kit for Self Closing Valve with Futura Knob (pictured)	
	1010795	151202039	Pre-Mix Valve Head Assembly Only	
	1001713	151689000	Spanner Wrench	
	1010796	151741039	Futura Valve Knob	

PRE MIX VALVES

	1007854	150792100	Fitting Elbow 7/16"--20(1/4"MFL) X 1/2"--16(5/16"MFL)	Order in Multiples of 10
	1005667	150792200	Fitting Elbow 1/2"--16(5/16"MFL)(2)	Order in Multiples of 10
	1010567	150794100	Yoke Fitting 7/16"--20(1/4"MFL)	
	1010401	150794200	Yoke Fitting 1/2"--16(5/16"MFL)	
	1009752	150238000	Screw, Yoke Fitting	Order in Multiples of 10
	1003975	150309000	O-ring, Yoke Fitting	Order in Multiples of 10
	1001357	150807100	Molded Fitting 7/16"--20(1/4"MFL) X 1/2"--16(5/16"MFL)	Order in Multiples of 10

PRE_MIX VALVES

PRE-MIX DISPENSING VALVE

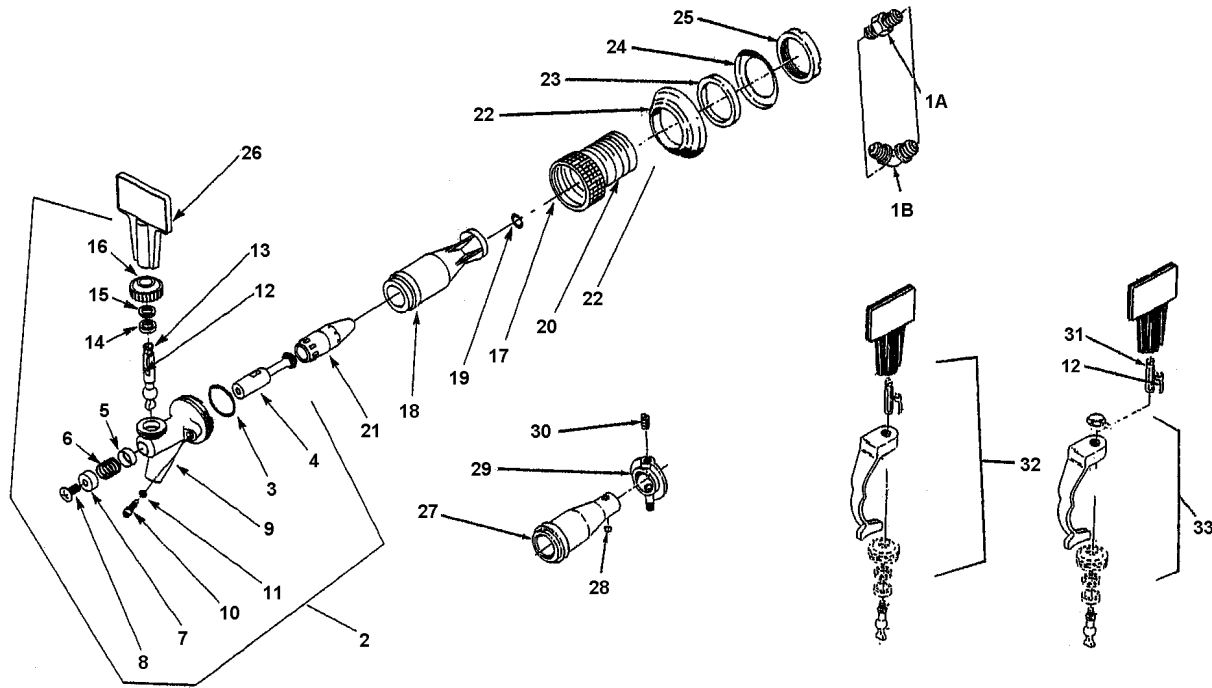

Item No.	Part No.	Description
1A	1001357	Fitting 1/4MF (7/16 – 20) by 5/16MF (1/2 – 16) Gray
	1001106	Fitting 5/16MF (2) (1/2 – 16) Red
1B	1007854	Elbow 1/4MF (7/16 – 20) by 5/16MF (1/2 – 16)
	1005667	Elbow 5/16MF (2) (1/2 – 16)
2	1010795	Dispensing Valve Assembly (Includes items 3 through 16)
3	1001860	O-Ring, 1.05 I.D. by .070 C.S.
4	1006399	Shaft and Seat Assembly
5	1005160	Sleeve, inner
6	1003174	Spring
7	1007285	Sleeve, Outer
8	1000339	Machine Screw, Phil Truss Hd., Chrome Plated Brass, No. 10-24 by 5/16 inches long
9	1010594	Body
10	1005348	Slotted Adjusting Screw
11	1001152	O-Ring, .114 I.D. by .070 C.S.
12	1003640	Lever Spring, Knob
13	1010721	Lever, Knob
14	1001339	Ball Washer, .390 I.D.
15	1008086	Friction Washer

Item No.	Part No.	Description
16	1008171	Bonnet, Knob
17	1003913	Coupling Nut
18	1004141	Shank Long
19	1003760	O-Ring, .301 I.D. by .070 C.S.
20	1008356	Sleeve, End Shank 2 1/8 (Standard)
21	1006426	Compensator Black
22	1005662	Flange Valve Black
23	1007876	Seal Shank Rubber
24	1007526	Washer, Seal Shank
25	1007860	Shank Nut
26	1010796	Knob
27	1006387	Shank Short Pre-Mix
28	1003975	O-Ring .208 I.D.
	1010567	Fitting Yoke 1/4MF (7/16 – 20)
29	1010401	Fitting Yoke 5/16MF (1/2 – 16)
	1009752	Screw Set 1/4 – 20 Stainless Steel
30	1009752	Screw Set 1/4 – 20 Stainless Steel
31	1009330	Lever Knob Short
32	1005813	Kit Push Lever with Knob
33	1008060	Kit Push Lever without Knob